

# Arduino IO Expansion

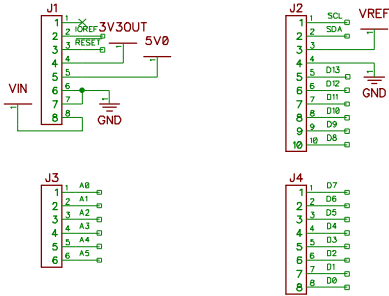

# Buzzer

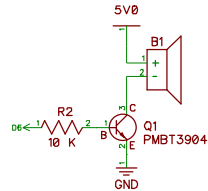

# 8x2 LCD

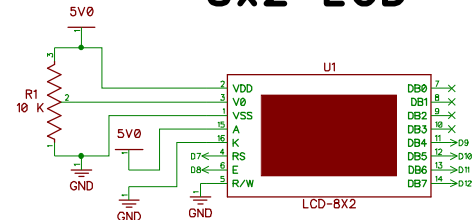

# User & Reset Push Buttons

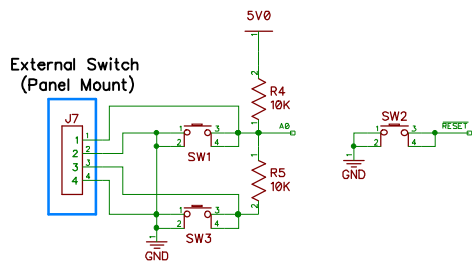

# SSR Interface

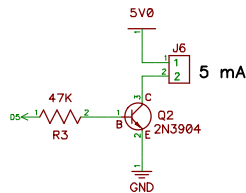

Connect to SSR for Oven/Heater Element

# Thermocouple Interface

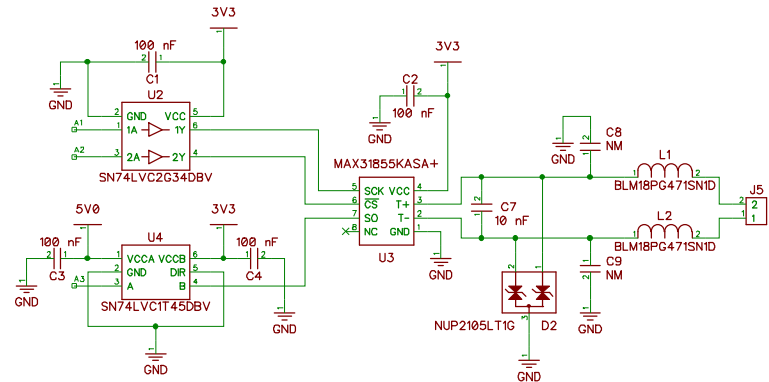

# Indicator LED

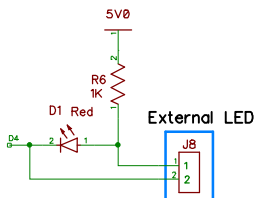

# Power Supply

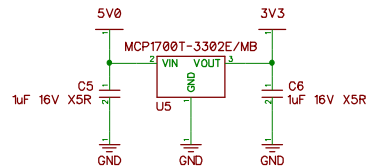

# Labels & Fiducial



Title: Reflow Controller Shield

Revision: 1.80

Date: 25-10-2012

Sheet 1

RS-REFLOW-CONTROLLER-SHIELD-1R80.dch

**rocket  
scream**